

Showering is now called
BetteAir.

The first shower tile:
BetteAir.

BETTE



**Opens the room up to
new ideas.**





Safe. Neat. Fitted in no time.

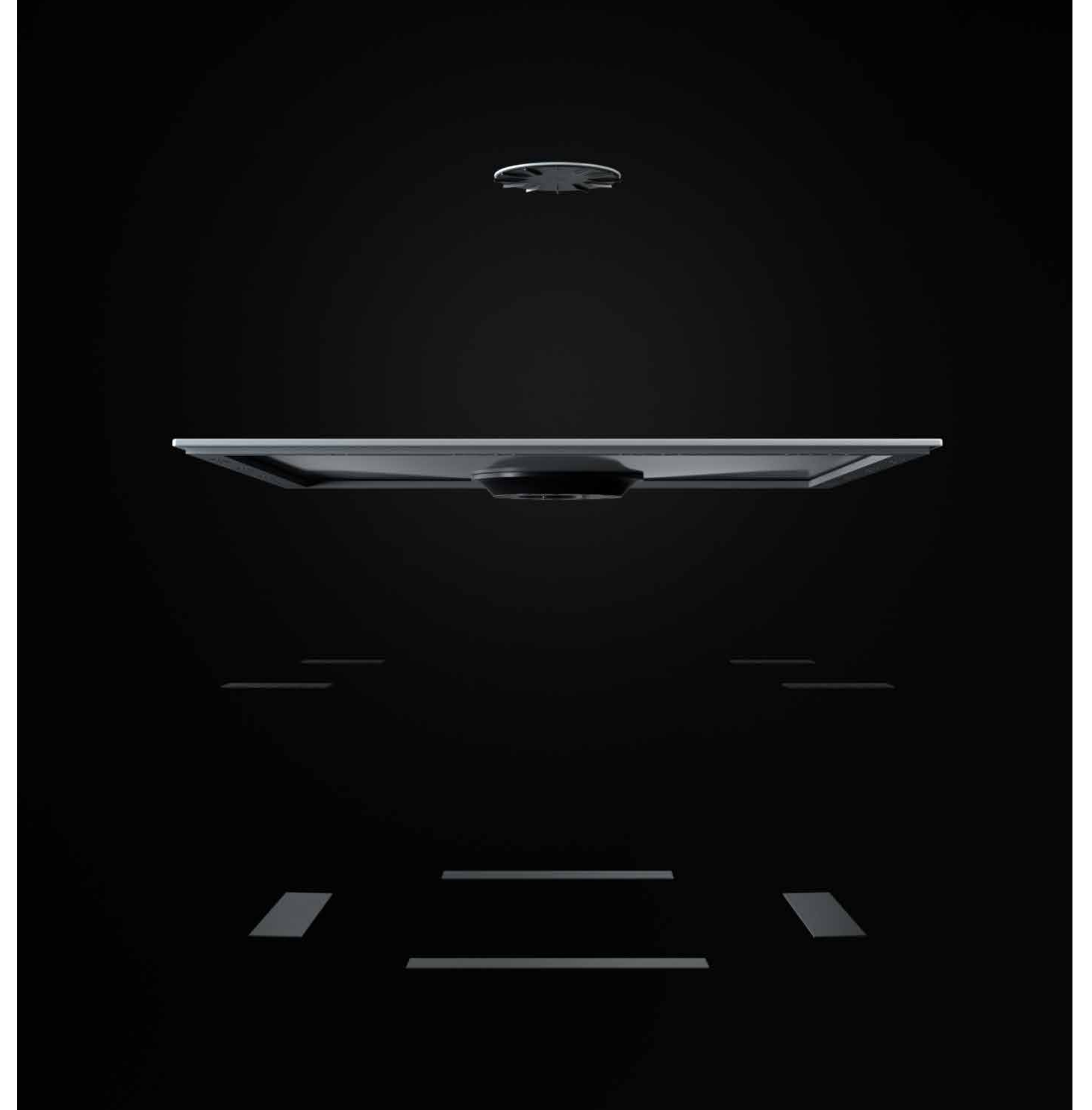

Pure form, innovative technology

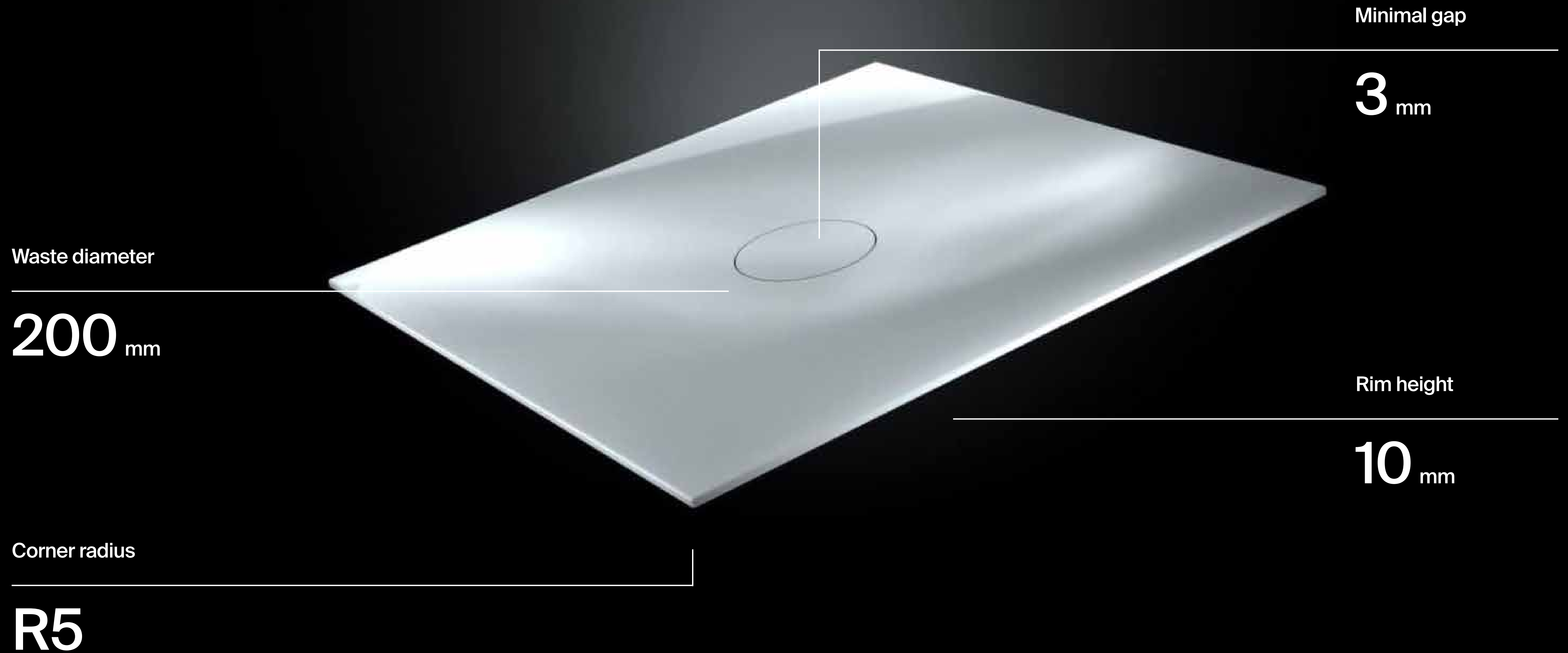

Reasons for the BetteAir shower tile? These are your advantages:

Reduced, timeless design

Suits any style direction.

Innovative drainage technology

Hair and dirt are safely washed away.

Easy interface coordination

Reduces the need for coordination on site.

Flush-mounted outlet cover

For maximum shower comfort.

Even easier to install

Saves time and money.





BetteAir waste fittings

- Waste fitting easy to clean.
- Hair and dirt are simply washed away.

→ **Air 30***

→ **Air 50**

→ **Air Down**

	BetteAir 30*	Installation height waste fitting in mm	48
	B524- Drainage capacity 0,6 l/s, water seal depth 30 mm	Total installation height in mm	97
	BetteAir 50	Installation height waste fitting in mm	68
	B525- Drainage capacity 0,6 l/s, water seal depth 50 mm, quality monitored to EN 274	Total installation height in mm	117
	BetteAirDown	Installation height waste fitting in mm	81
	B599- Drainage capacity 0,6 l/s, water seal depth 50 mm, quality monitored to EN 274	Total installation height in mm	62

*not standard-compliant

BetteAir

Installation options

1

Plug and Play installation

Installation directly on the screed with our pre-assembled minimum tray support.

2

Our flexible solution

Installation directly on the unfinished floor with our Universal installation system.



Installation option 1

Plug and Play. Done.

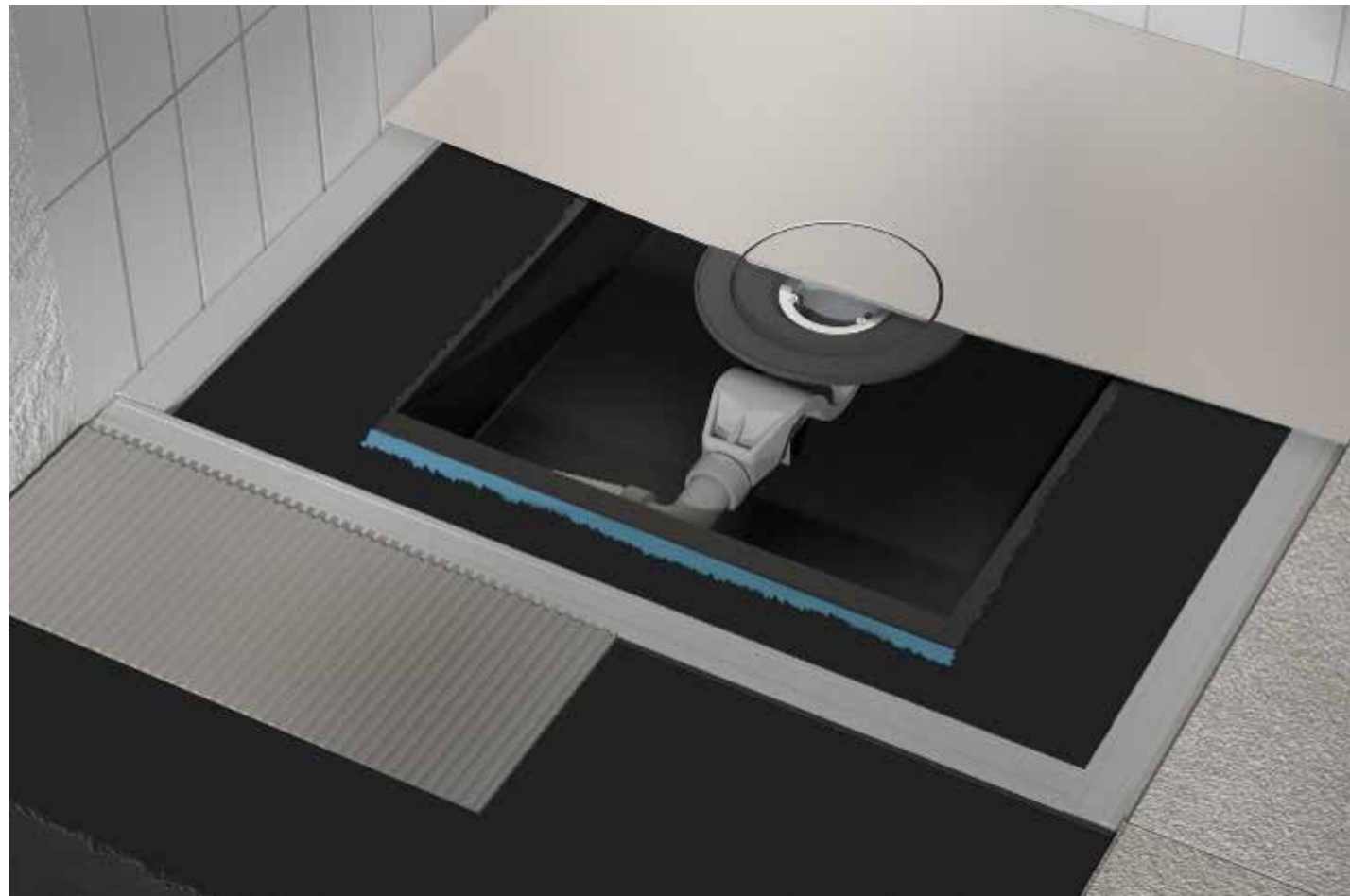

→ Minimum Support



→ Waste fittings

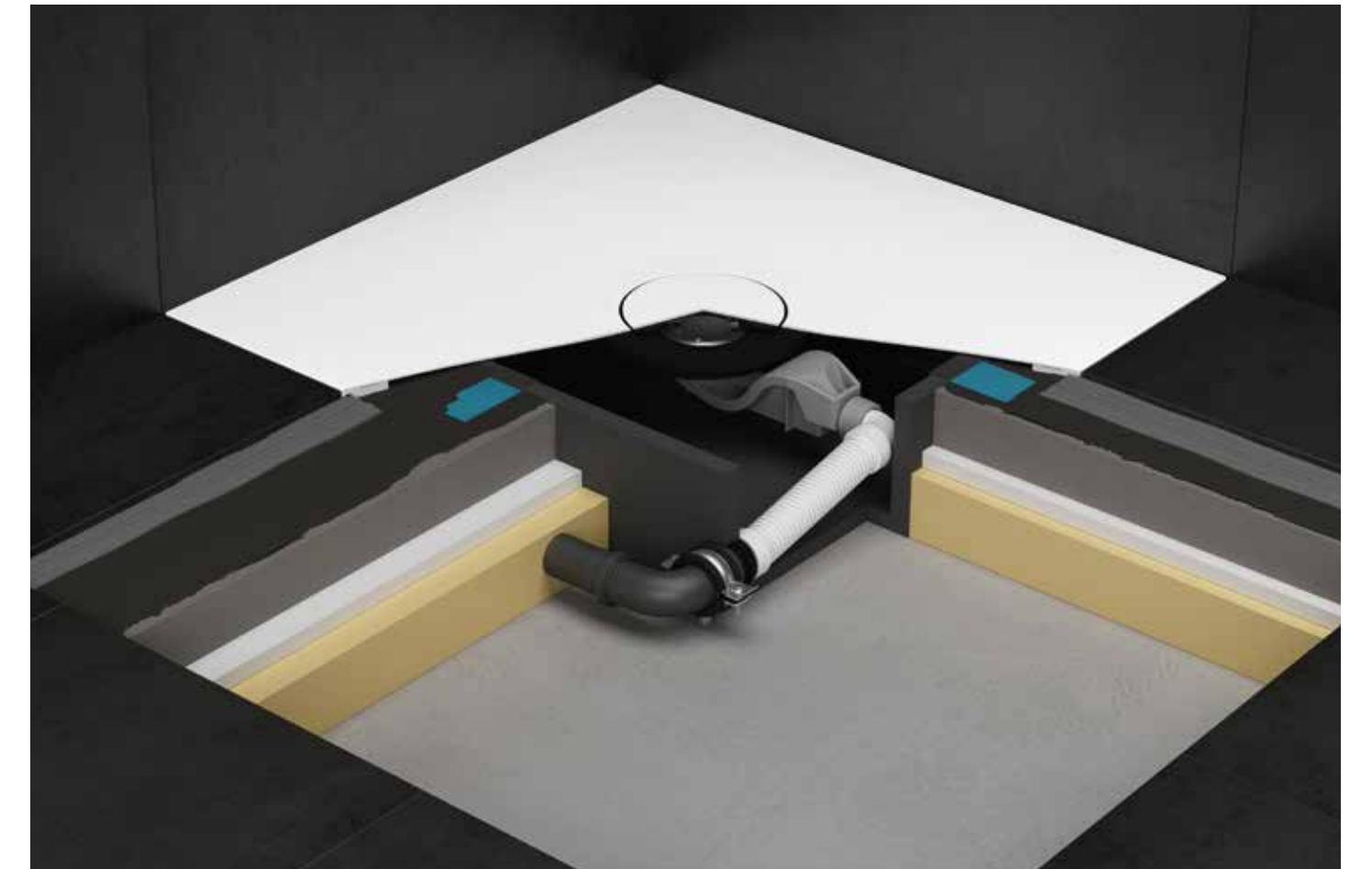

→ Installation Box BetteAir

Installation option 1

Plug and Play. Done.

→ [Installation video](#)



Noise level only
19dB(A) as per
DIN 4109
VDI 4100*2



Waterproof
ETAG 022
DIN 18534

*2 Structural conditions according to test certificate.



1 Choose measurement

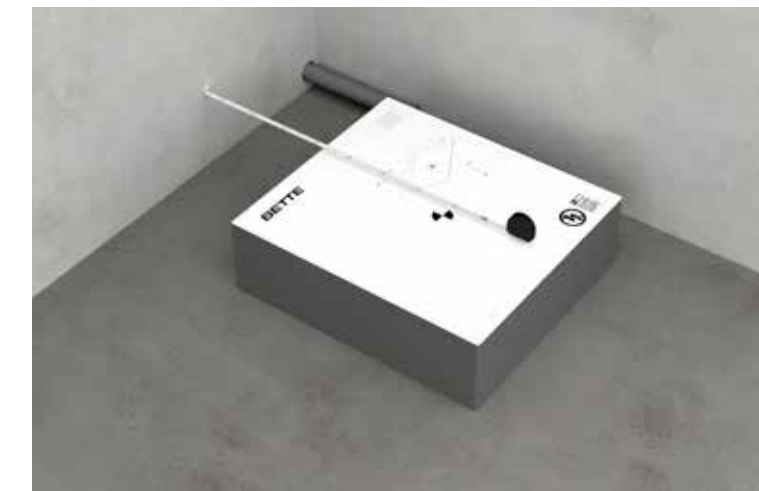

2 Position box



3 Integrate in floor

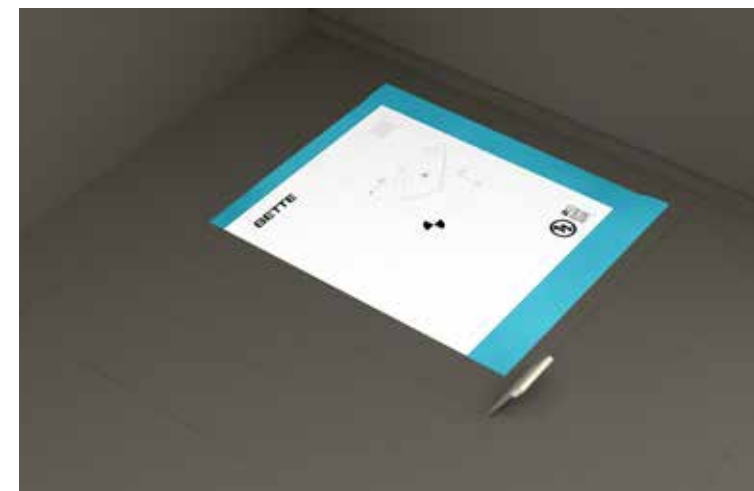

4 Seal

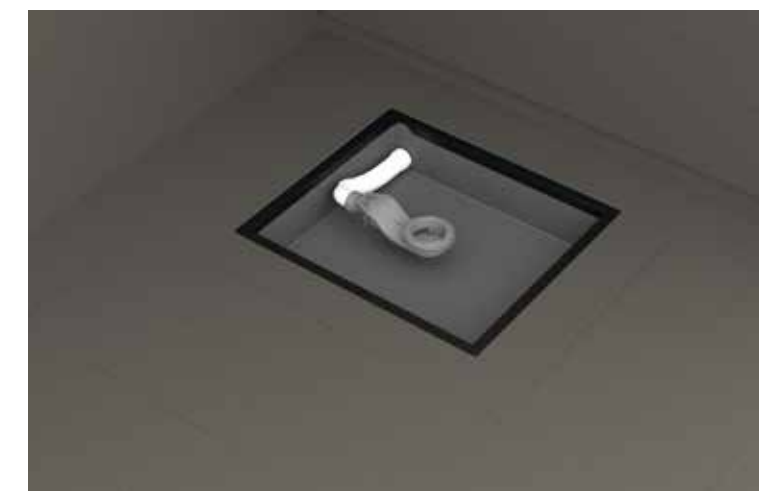

5 Insert set

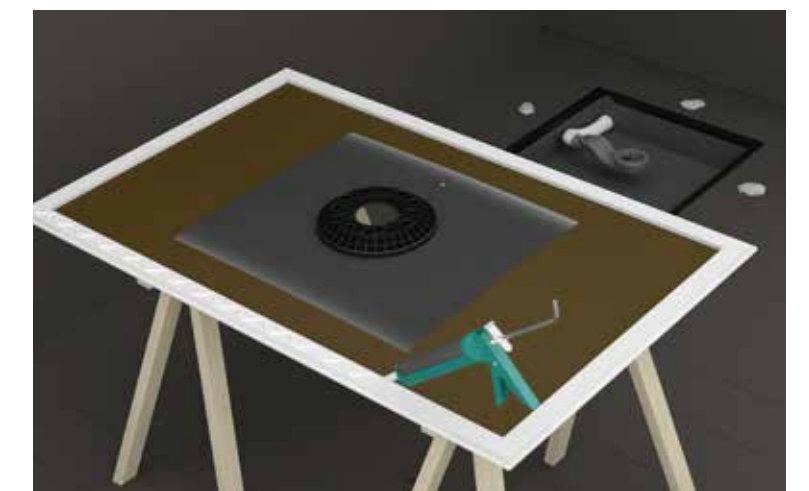

6 Apply adhesive

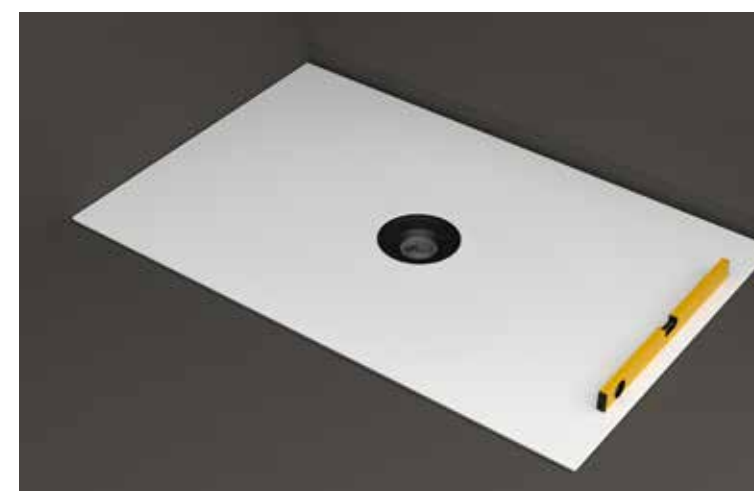

7 Position shower tile

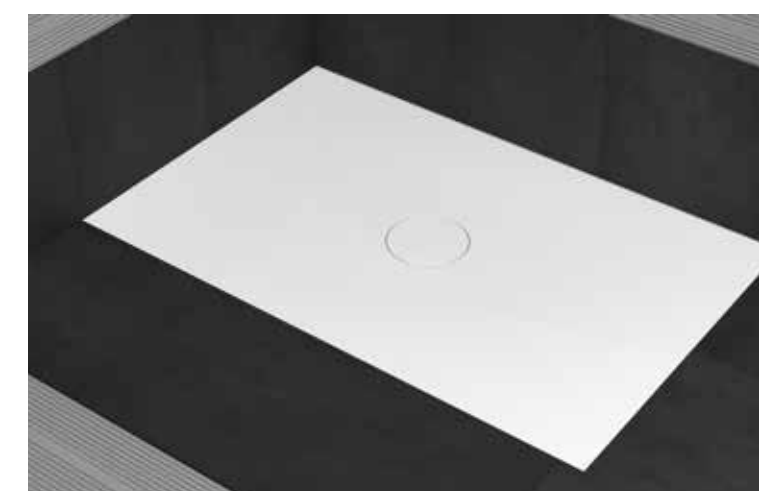

8 Tile

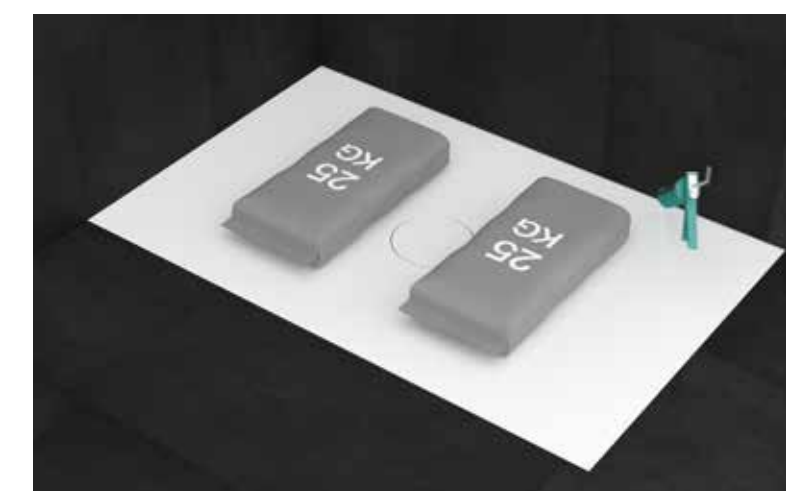

9 Load shower tile

Installation option 1

Plug and Play. Done.

Installation heights with minimum support and BetteAir installation box

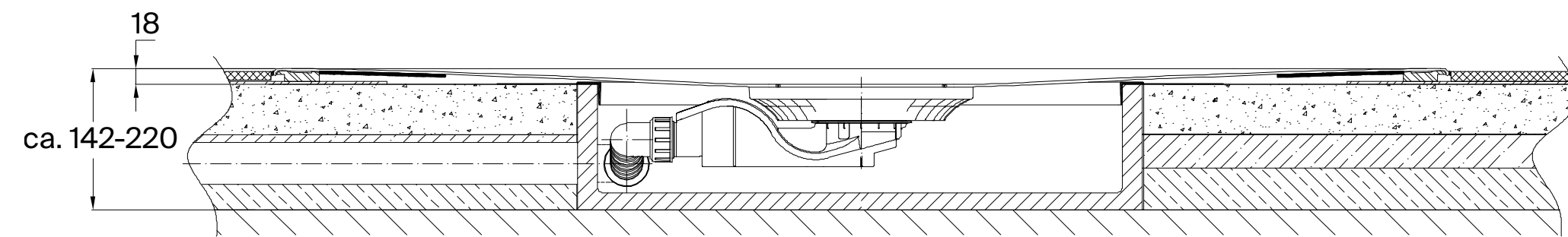

Representation BetteAir installation box with waste fitting BetteAir 50 – 0.6 l/s, with water drainage on the side, standard-compliant water seal depth 50 mm to EN 274

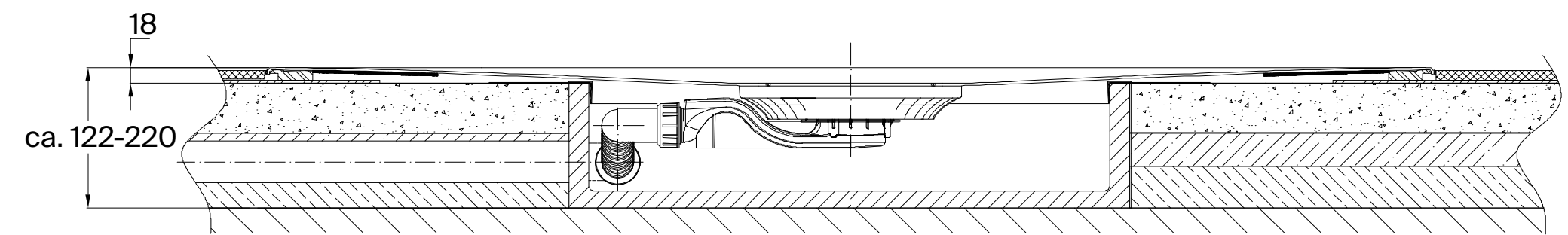

Representation BetteAir installation box with waste fitting BetteAir 30* – 0.6 l/s, with water drainage on the side, water seal depth 30 mm

*not standard-compliant

Installation option 2

Easy and universally flexible.

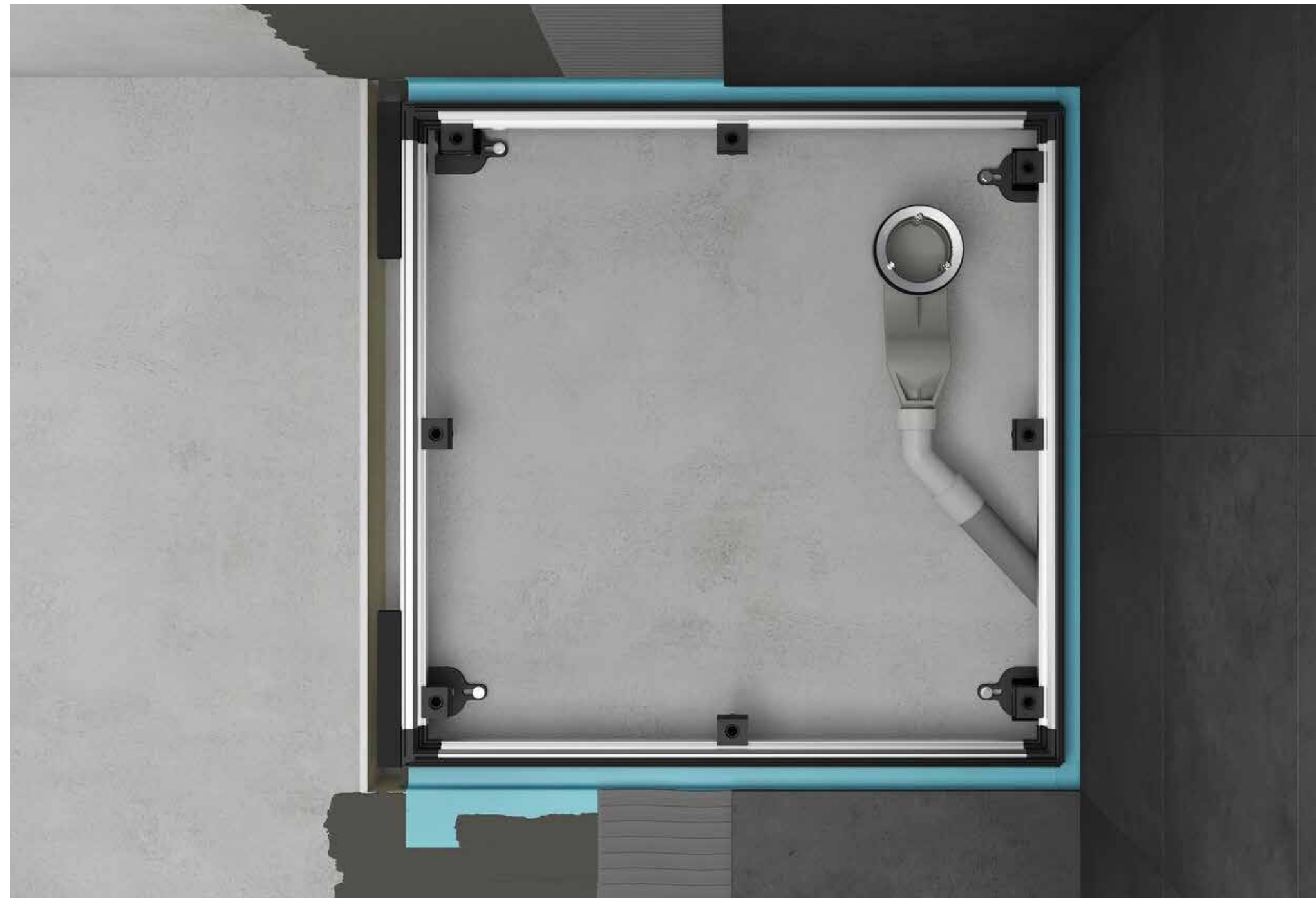

→ Installation System Universal



→ Waste fittings

Installation option 2

Easy and universally flexible.

→ Installation video



Noise level only
20 dB(A)
as per DIN 4109*2



Waterproof
ETAG 022
DIN 18534

*2 Structural conditions according to test certificate.



1 Fit together



2 Attach feet

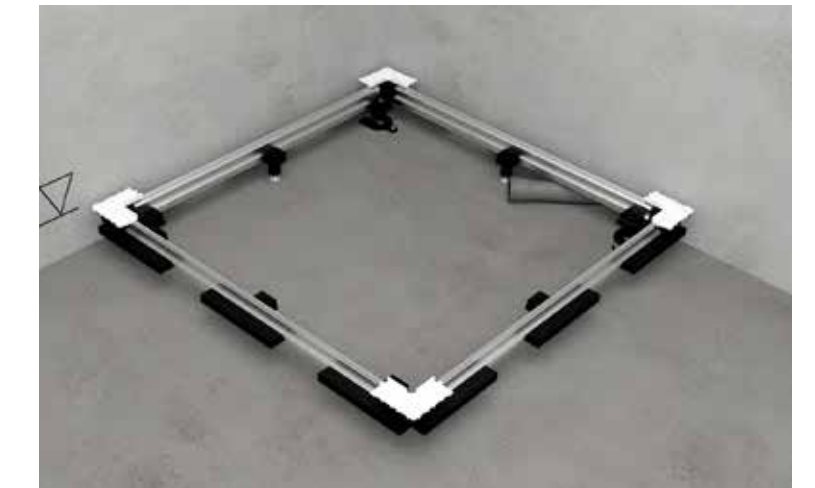

3 Position frame

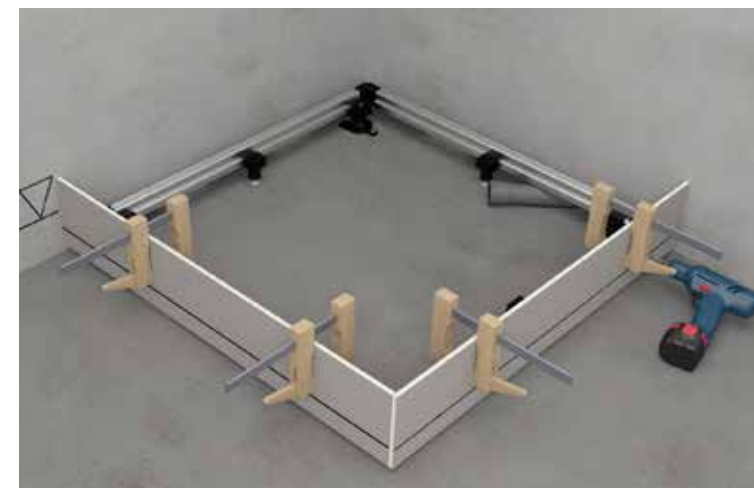

4 Mount



5 Prepare floor

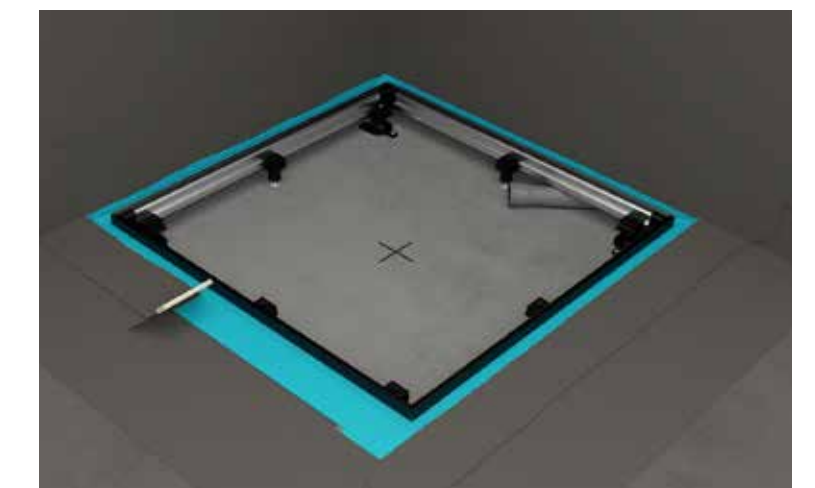

6 Connect seal

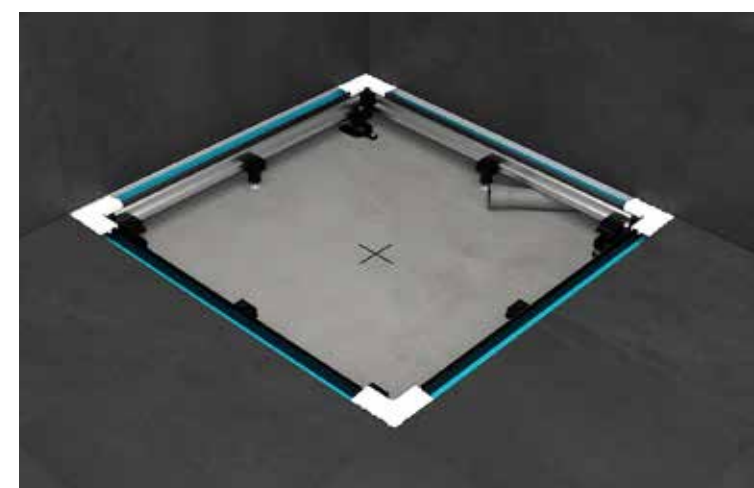

7 Tile

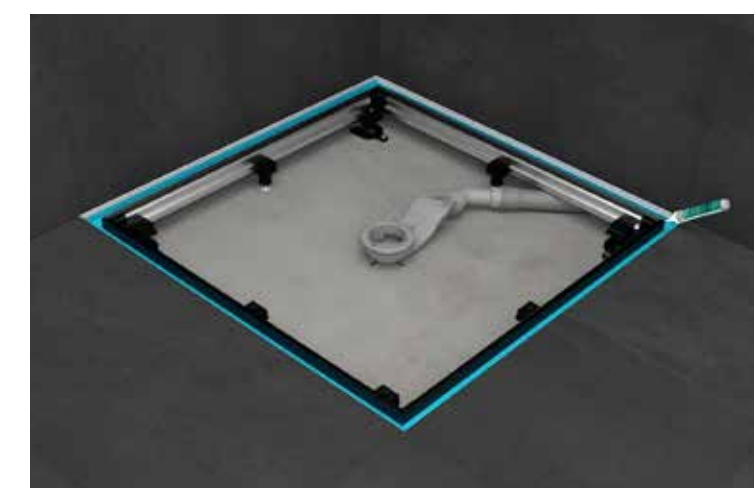

8 Fine installation

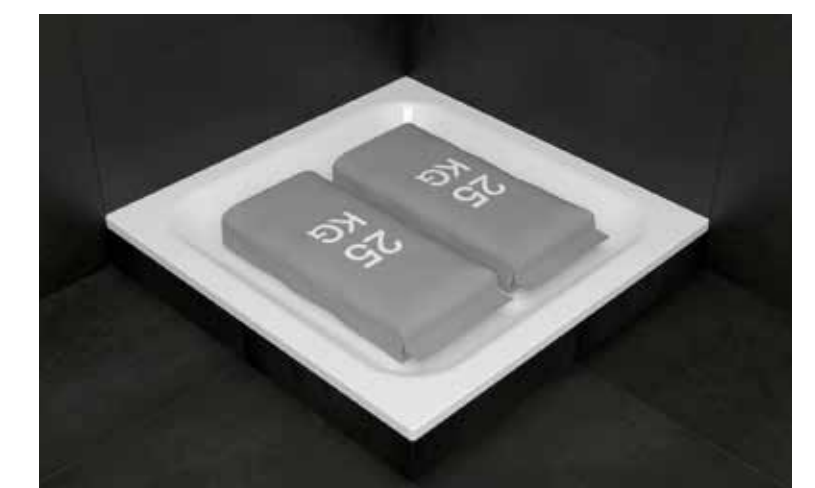

9 Insert shower tile

Installation option 2

Easy and universally flexible.

Installation heights with Universal installation system

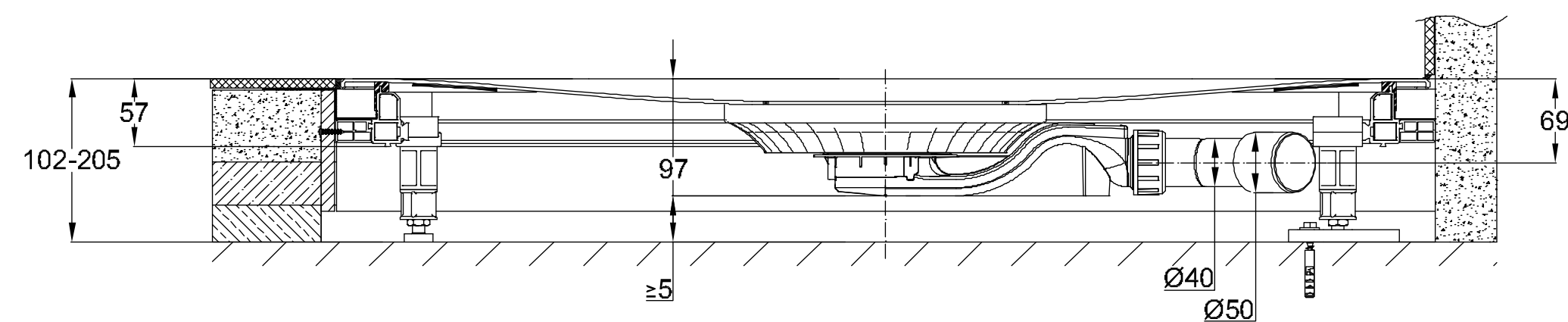

Representation Universal installation system with waste fitting BetteAir 30* – 0.6 l/s, with water drainage on the side, water seal depth 30 mm

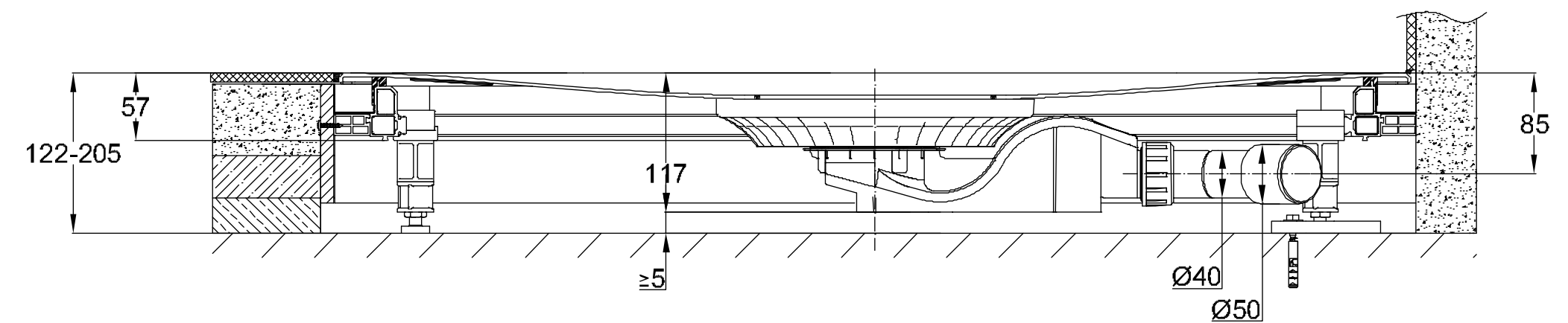

Representation Universal installation system with waste fitting BetteAir 50 – 0.6 l/s, with water drainage on the side, standard-compliant water seal depth 50 mm to EN 274

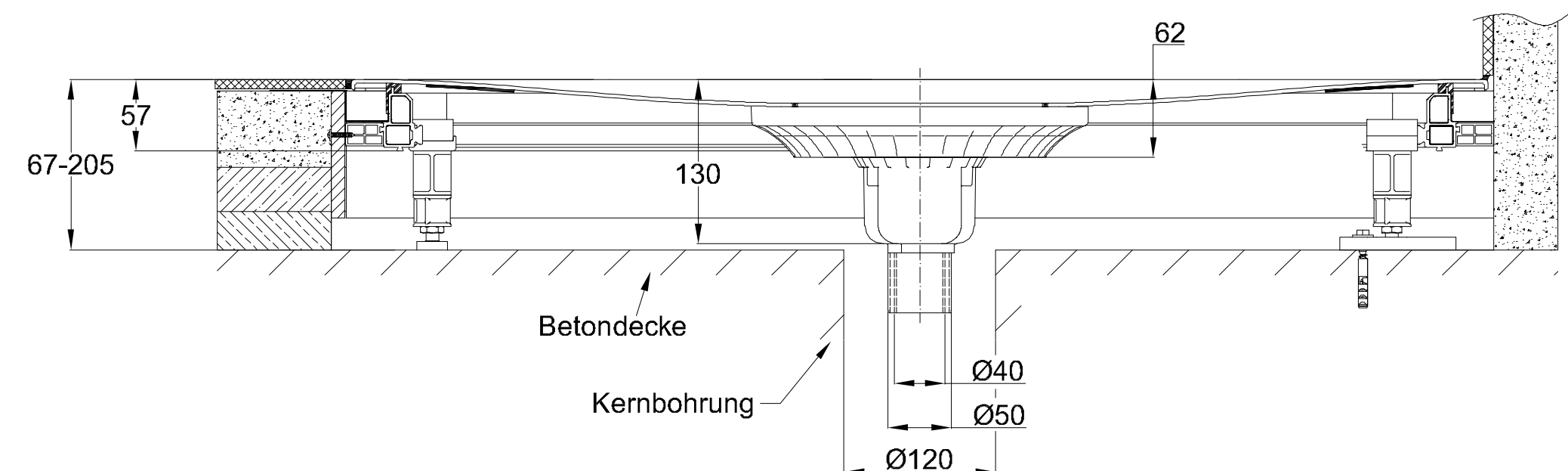

Representation Universal installation system with waste fitting BetteAir Down 0.6 l/s, with vertical water drainage, water seal depth 50 mm

*not standard-compliant

BetteAir dimensions

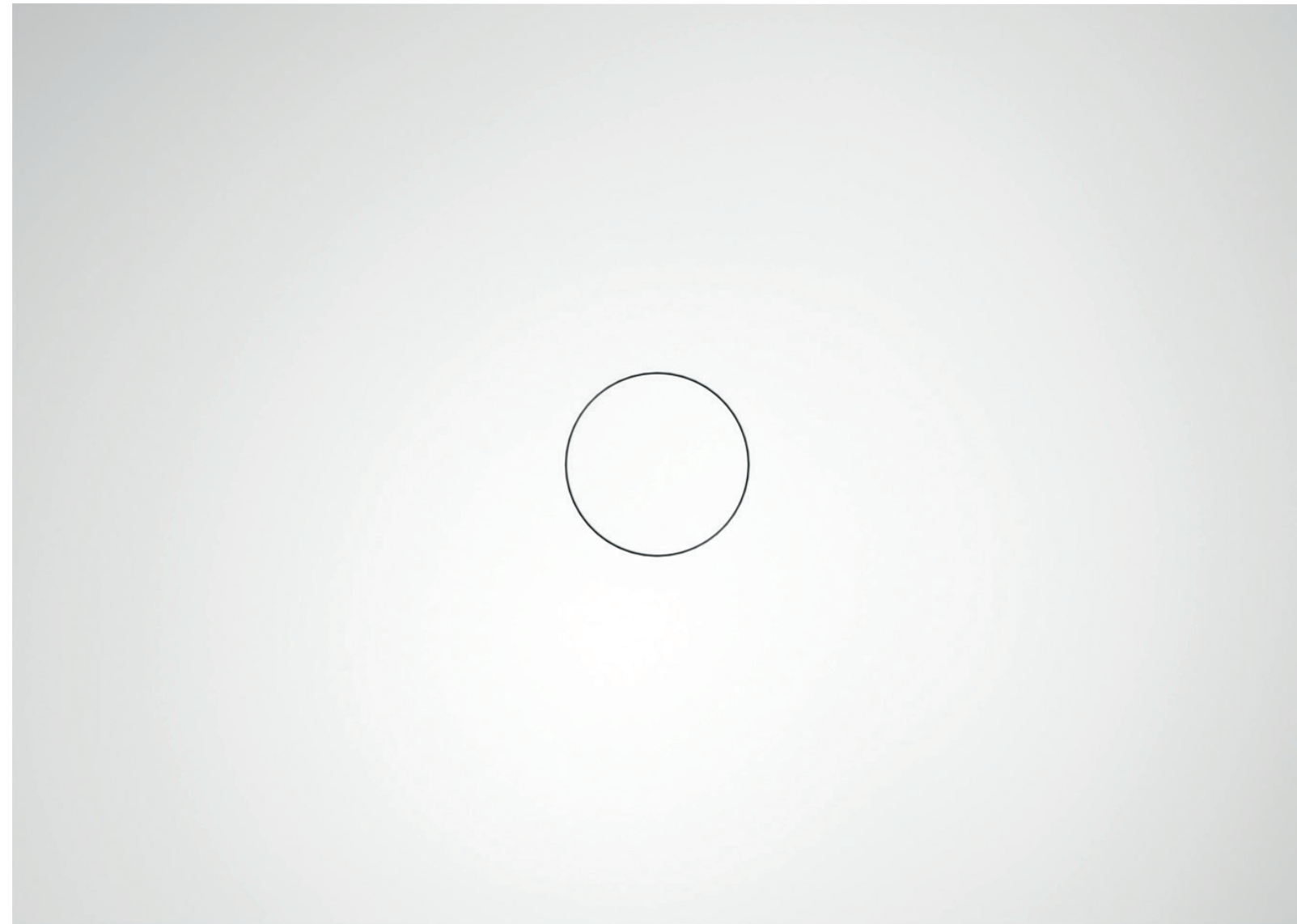

BetteAir L × W (mm)

900 × 900	1200 × 800	1500 × 900
1000 × 800	1200 × 900	1500 × 1000
1000 × 900	1200 × 1000	1600 × 900
1000 × 1000	1200 × 1200	1600 × 1000
1100 × 900	1400 × 900	
1100 × 1000	1400 × 1000	

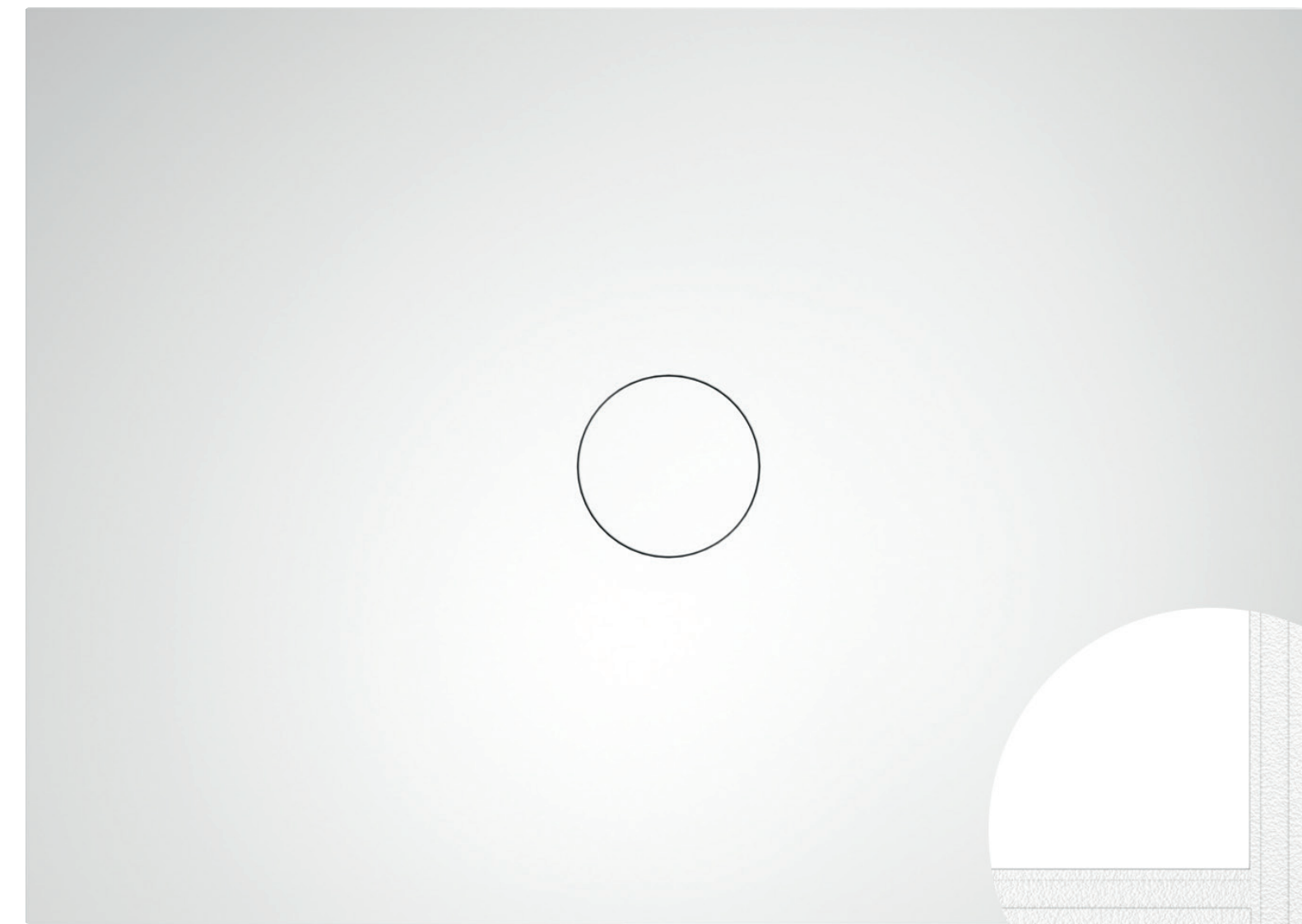

BetteAir with Minimum Support L × W (mm)

900 × 900	1200 × 800	1500 × 900
1000 × 800	1200 × 900	1500 × 1000
1000 × 900	1200 × 1000	1600 × 900
1000 × 1000	1200 × 1200	1600 × 1000
1100 × 900	1400 × 900	
1100 × 1000	1400 × 1000	

**Only stands out if you
want it to.**



Matt colours

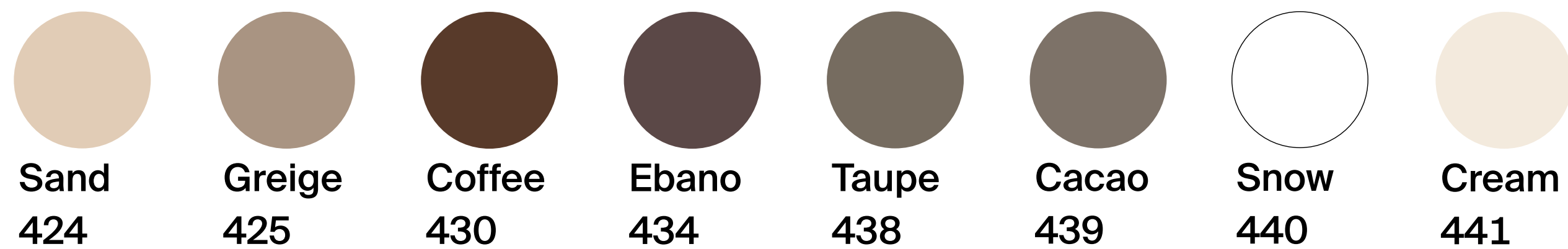

Gloss colours

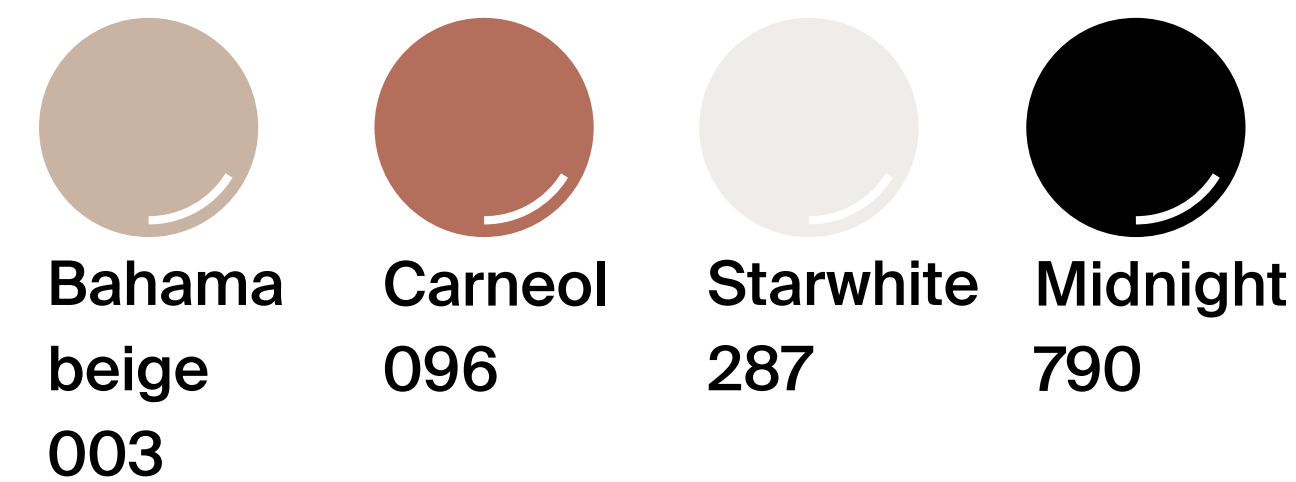

BetteAir

Additional features



→ BetteAnti-Slip Pro

Complies with rating group B to DIN 51097 and rating class R10 to DIN 51130. For selected matt and gloss colours.



→ BetteAnti-Slip Sense



BetteAnti-Slip Sense meets the highest requirements of assessment group C according to DIN 51097 - confirmed by TÜV Rheinland LGA with test report BTV 21V30174-01. We guarantee this for 30 years. Can be combined with colour white 000.



→ BetteGlaze® Plus

Water droplets roll down more easily. Simply wipes clean with a damp cloth. This saves time and is much better for the environment. Cannot be combined with BetteAnti-Slip Pro or BetteAnti-Slip Sense.

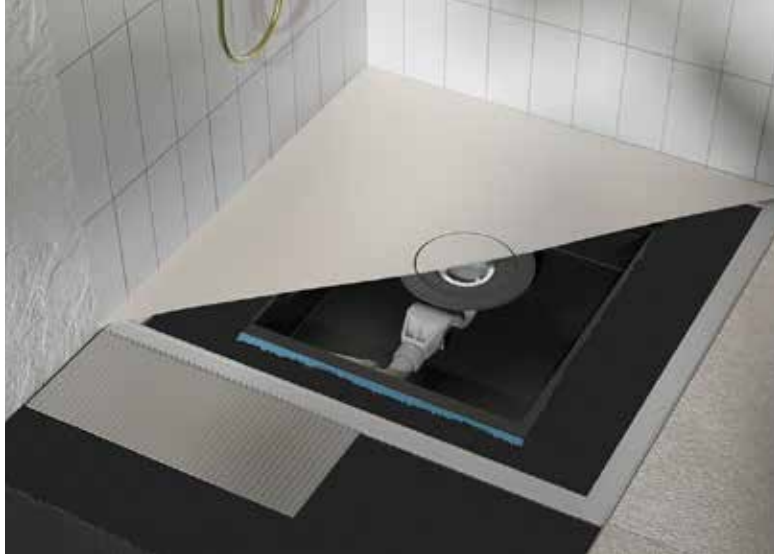
Overview of BetteAir

	Installation options	Sound insulated to DIN4100	to DIN 4109	Waste fitting	Water seal depth	Total installation height
	Plug & Play → BetteAir with Minimum Support → Installation Box	19 dB(A)	19 dB(A)	Air 30* Air 50	30 mm* 50 mm	from 122 mm from 142 mm
	Flexible installation → BetteAir → Installation System Universal	18 dB(A)	20 dB(A)	Air 30* Air 50 Air Down	30 mm* 50 mm 50 mm	from 97 mm from 117 mm from 67 mm

[→ Product configurator](#)

*not standard-compliant

BetteAir.
Sheer perfection.

my-bette.com

BETTE